

MIYOTA

Cal. JP15 / 25

MULTIFUNCTION



1. Basic Specification

Calibre	JP15	JP25
Ligne	12 1/2"	
Overall diameter	Φ28.2 × 26.0 (3H-9H)	
Case fitting diameter	Φ27.6 × 26.0 (3H-9H)	
Total height	4.30mm	
Battery Life	Approx.2years	
Battery	SILVER OXIDE SR621SW or equivalent	

< Time Standard >

Type of quartz: Tuning fork type quartz crystal

Frequency : 32,768Hz

Accuracy : ±20 second / month worn under normal circumstances

< Balanceable weight of hand >

Minute hand Max. 0.4μN.m

Second hand Max. 0.09μN.m

Other small hands Max. 0.02μN.m

< Function >

Date calendar

Day/ 24Hours/ 24Hours Dual time display by means of hands

Powercell Saving Reset Mechanism(PSRM)

Over-loading Compensation Device(OLCD)

Digital Frequency Control(DFC) for time adjustment

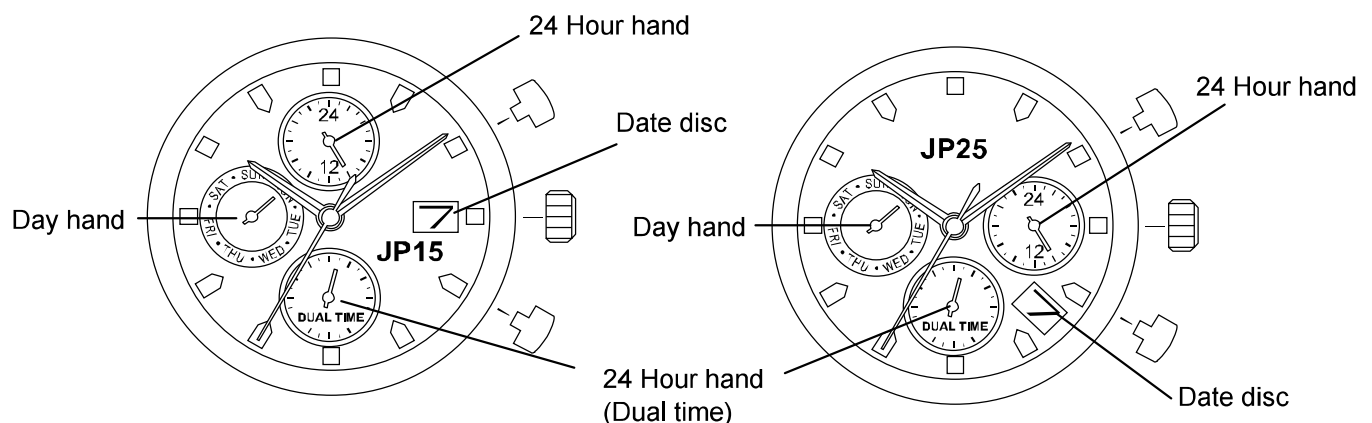

2. Separated Parts

Setting stem	065- 505 × 1
Length from movement center to far end of setting stem	20.03mm
Thread	Φ 0.9mm × 11.68mm

3. Others

* Measurement of time rate

The unit(gate) time of measurement must be set at "10 sec." or integer fold value of 10 sec. Owing to the DFC system, and the measurement must be performed in the form of complete watch.

* Marking on movement

JAPAN
MIYOTA CO.
(CAL. NO.)
NO JEWELS

* Typical clearance

Mov't - Caseback minimum 150 microns
Top of hands - Glass 300 - 400 microns *

* subject to the glass, case structure, and the length of hand

4. Instruction Manual

【Displays and Buttons】

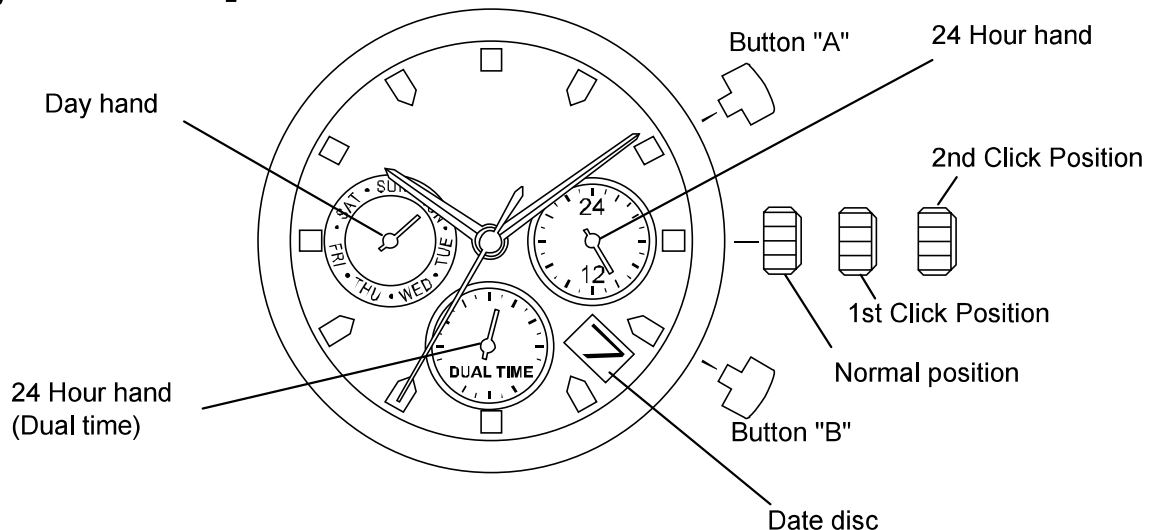

A) SETTING THE DAY

1. Pull the crown out to the 2nd Click Position.
2. Turn the crown clockwise to set the day.
3. After the day has been set, push the crown back to the Normal position.

* The day is changed during the period from 0AM to 5AM.

B) SETTING THE DATE

1. Pull the crown out to the 1st Click Position.
2. Turn the crown clockwise to set the date.
 - * If the date is set between the hours of around 9:00 PM and 1:00 AM, the date may not change on the following day.
3. After the date has been set, push the crown back to the Normal position.

C) SETTING THE TIME

1. Pull the crown out to the 2nd Click Position.
2. Turn the crown clockwise to set hour and minute hands.
3. After the time has been set, push the crown back to the Normal position.

D) SETTING THE DUAL TIME

Press button "A" to set the dual time hand forward in units of 15 minutes.

Press button "B" to set the dual time hand back in units of 15 minutes.

*The dual time hand can be put rapidly by continuously pressing button "A" or "B".

These specifications might be changed without prior notice.

CITIZEN WATCH CO., LTD.

Coordinates

記号	X	Y
GM	0	0
DH11	9359	-9359
DH12	-12271	4958

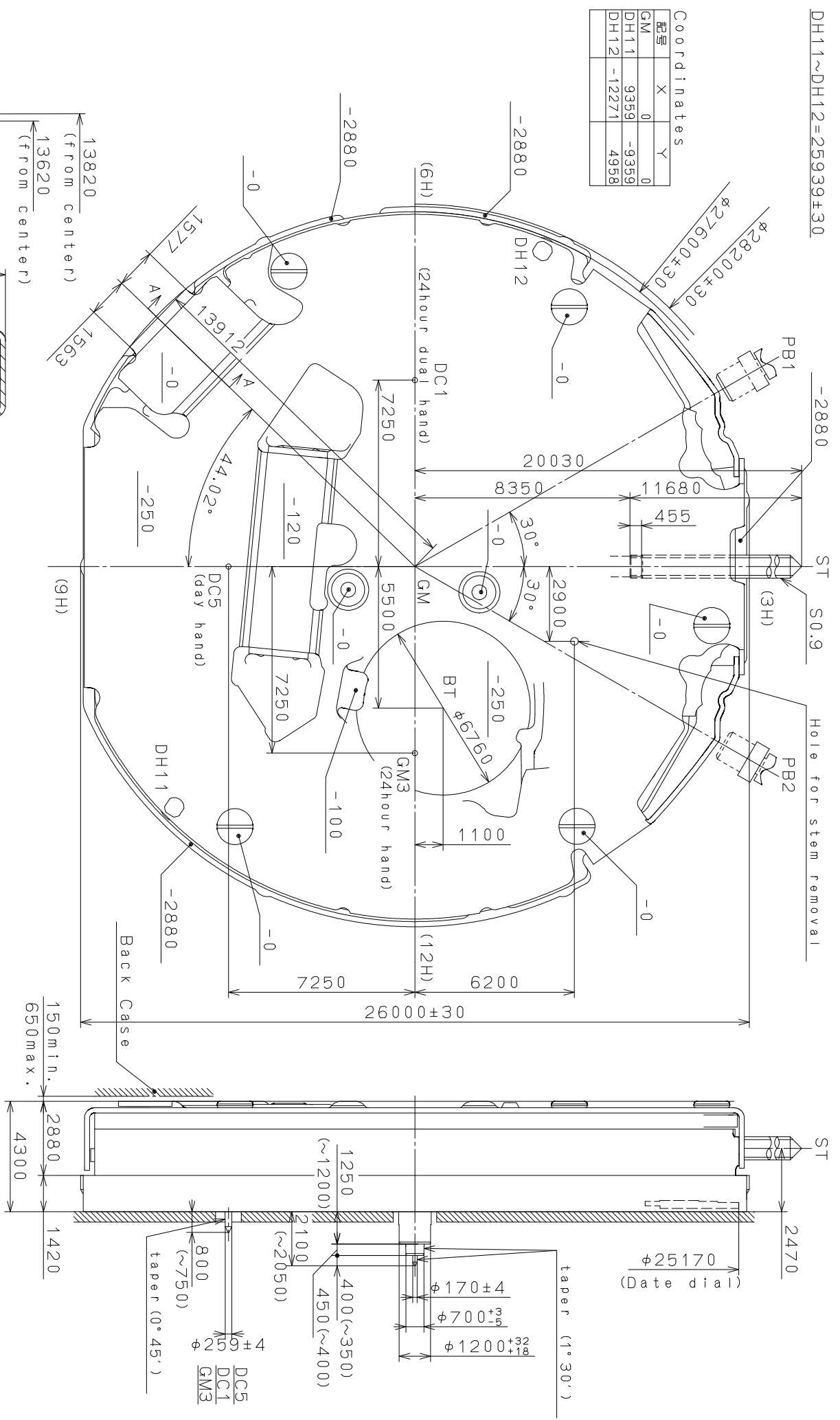

Section PB1,2

Section A-A

Quantity	Unit	Cal. No.:
1	1/1000mm	JP15
Scale	7:1	Parts No.:
Date	Drawn	Name:
Checked	Approved	Frame for Case
Mark Date Description Appr. Checked N. Suzuki		
Alterations		
Material		
Heat Treatment		
Hardness		
Plating		
General Tolerances		
Dimensions		
Angles		
Drawing No.: JP15C0AS		
CITIZEN WATCH CO., LTD. TOKYO, JAPAN		



confidential papers 2012/12/10 (11:26:10)

This drawing is provisional and subject to our reconfirmation and/or revision without notice.

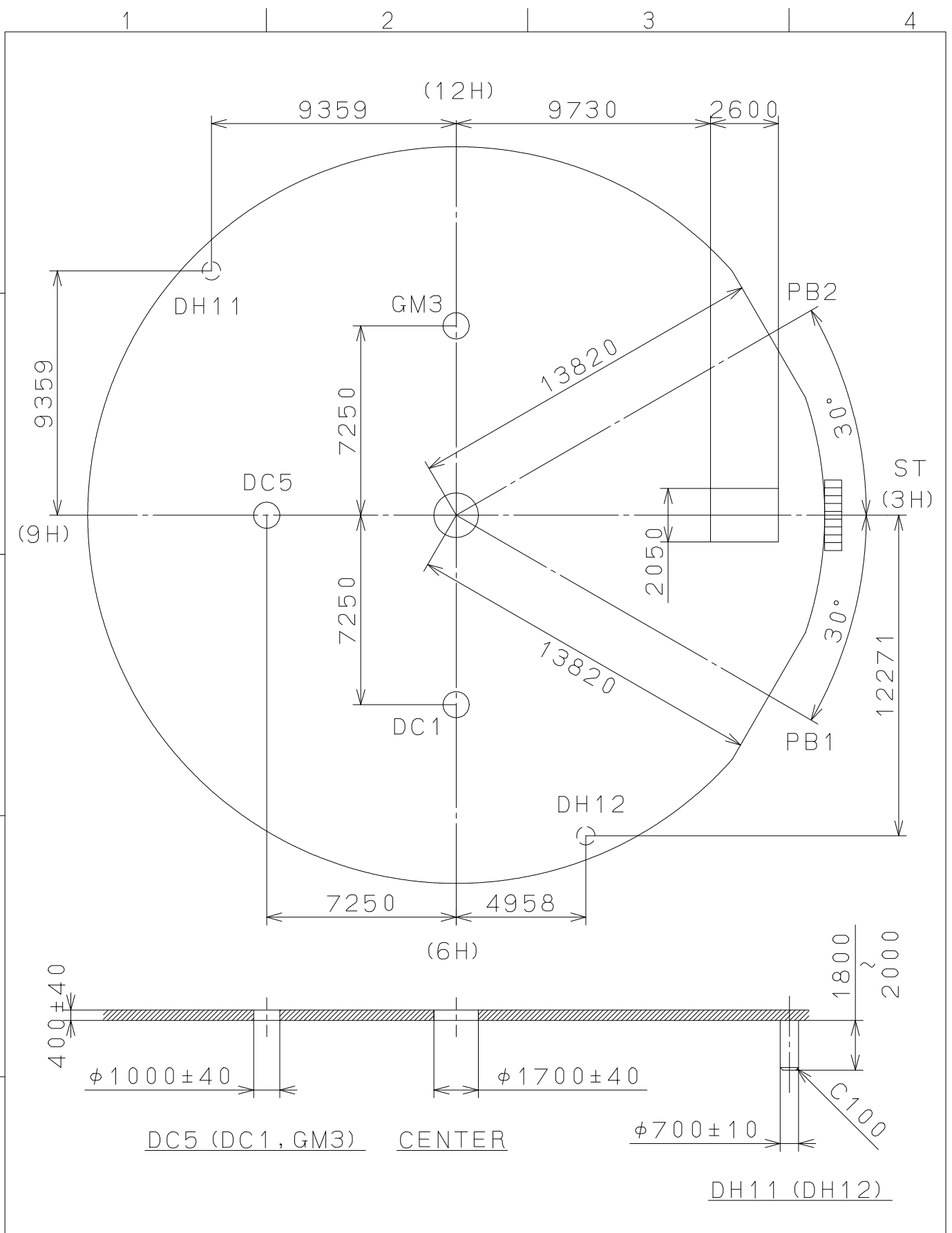

△			Quantity		Cal.NO.:
△			Unit	1/1000 _{mm}	JP15-00C
△			Scale	5:1	Parts No.:
△			Date		
△			Drawn		
Mark	Date	Description	Appr.	Checked	Name:
		Alterations		Approved	Indications for Dial
Material					Drawing No.:JP15D0AS
Heat Treatment				General Tolerances	MIYOTA
Hardness				Dimensions	
Plating				Angles	
					CITIZEN WATCH CO.,LTD. TOKYO,JAPAN

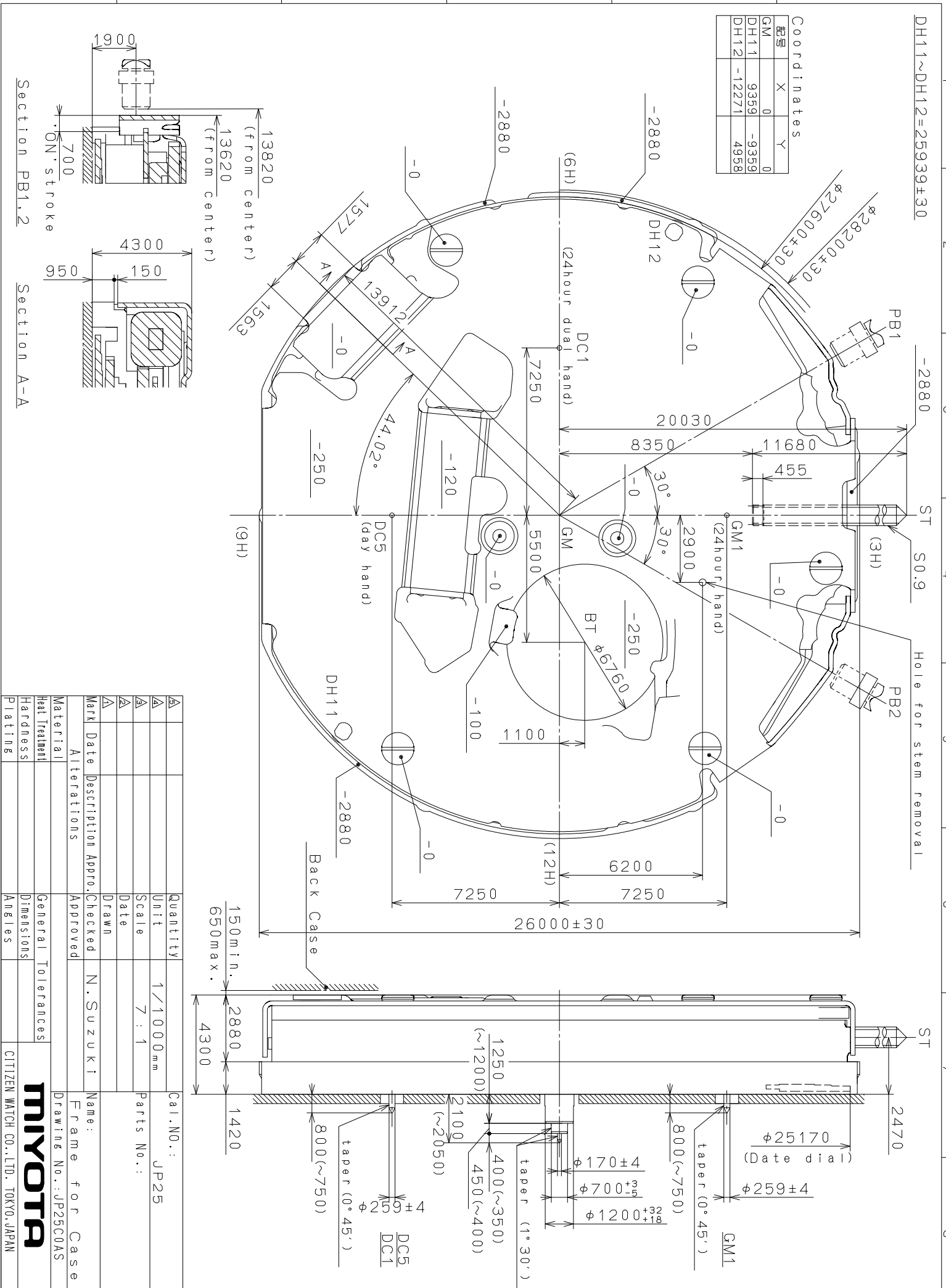

Coordinates

記号	X	Y
GM	0	0
DH11	9359	-9359
DH12	-12271	4958

Section PB1,2

Section A-A

△	Quantity	Unit	Cal. No.:
△	1/1000	mm	JP25
△	Scale	7:1	Parts No.:
△	Date	Drawn	Name:
△	Mark	Description	Frame for Case
△	Date	Appr.	Drawing No.:
△	Alterations	Checked	JP25C0AS
△	Material	Approved	N. Suzuki
△	Heat Treatment		
△	Hardness		
△	Plating		

MIYOTA
CITIZEN WATCH CO., LTD. TOKYO, JAPAN

This drawing is provisional and subject to our reconfirmation and/or revision without notice.

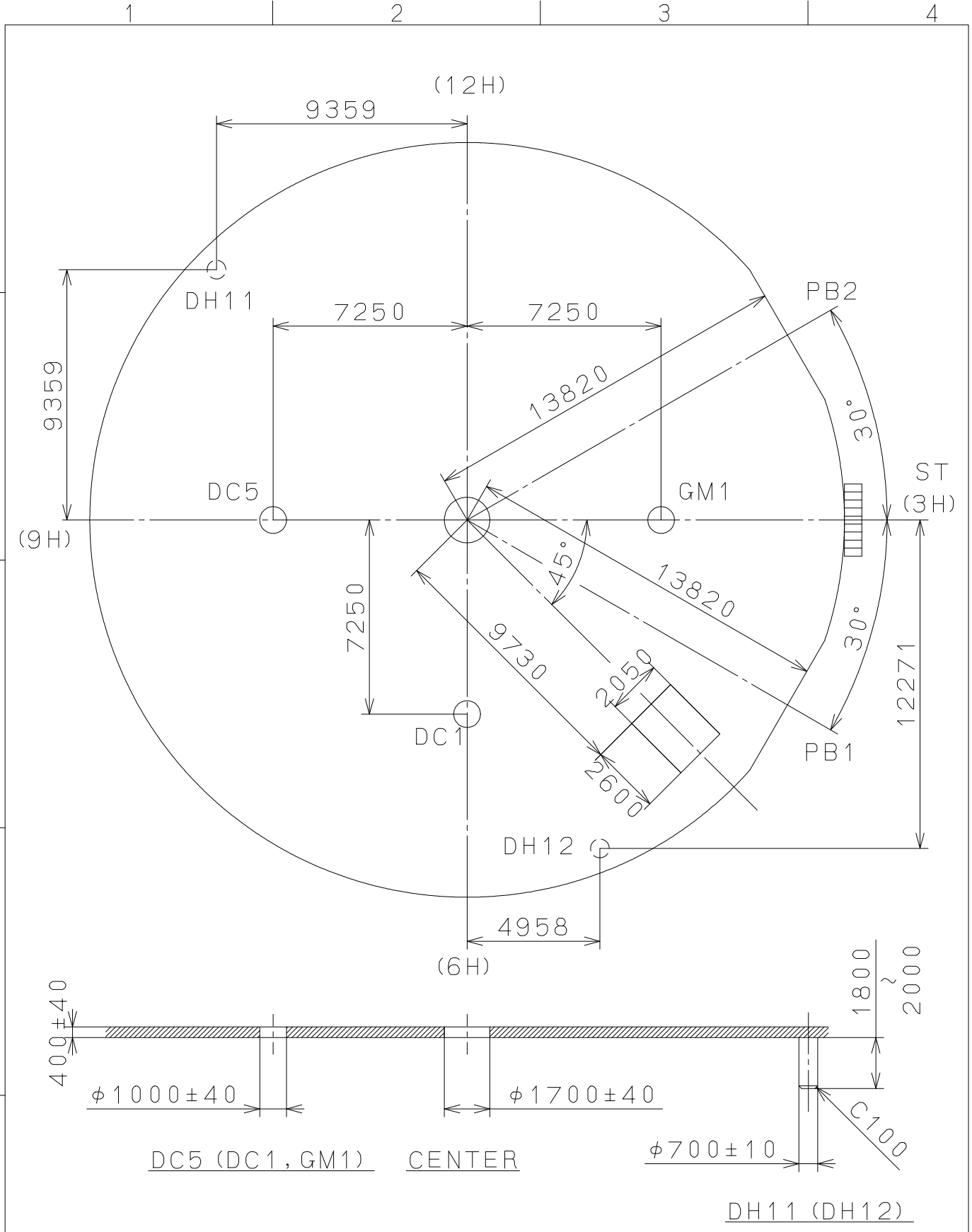

△			Quantity		Cal.NO.:
△			Unit	1 / 1000 mm	JP25-00C
△			Scale	5 : 1	Parts No.:
△			Date		
△			Drawn		
Mark	Date	Description	Appr.	Checked	Name:
		Alterations		Approved	Indications for Dial
Material					Drawing No.: JP25D0AS
Heat Treatment				General Tolerances	MIYOTA CITIZEN WATCH CO., LTD. TOKYO, JAPAN
Hardness				Dimensions	
Plating				Angles	

2006/12/25 (07:50:10)

This drawing is provisional and subject to our reconfirmation and/or revision without notice.

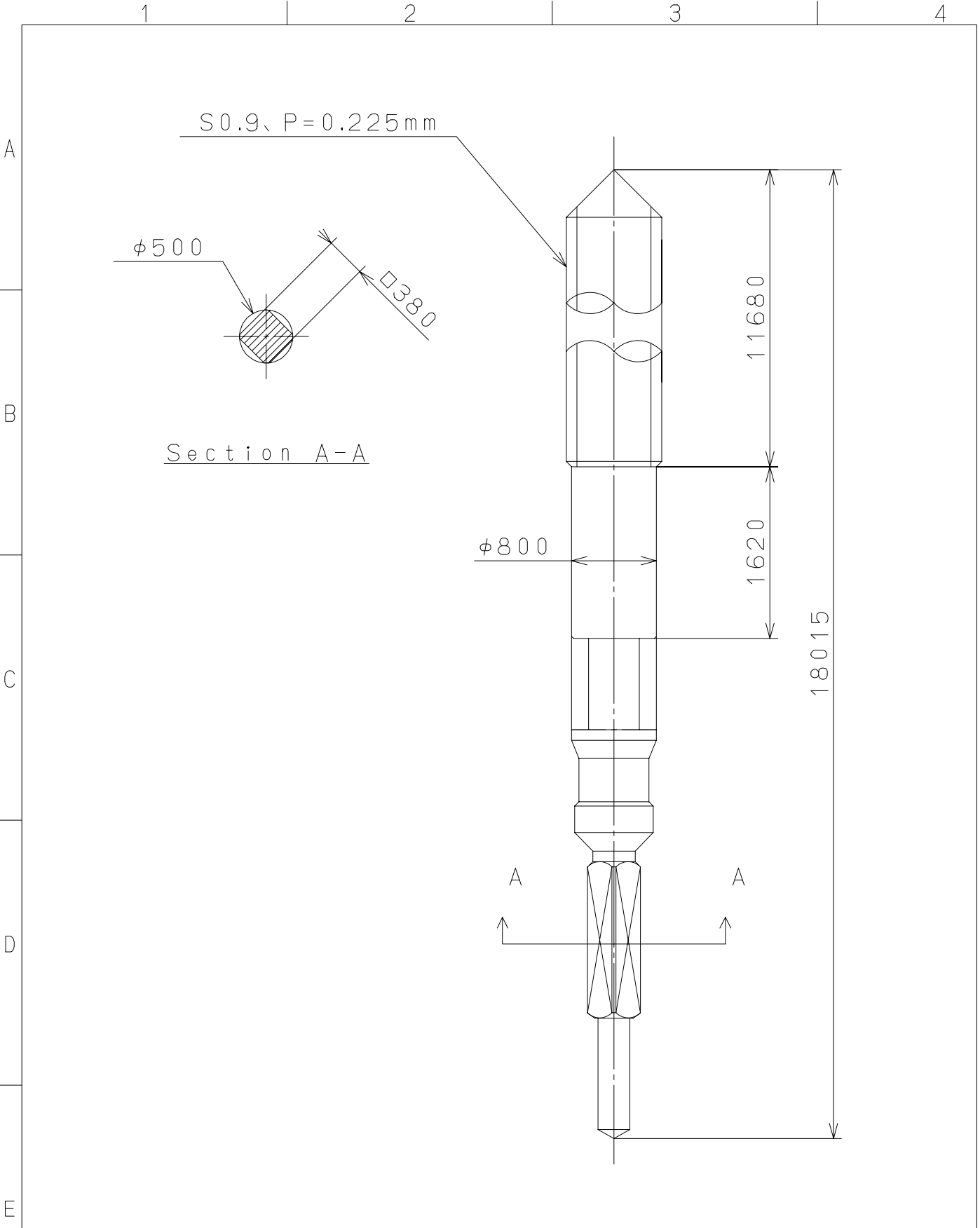

⑤			Quantity		Cal.NO.:
④			Unit	1 / 1000 mm	
③			Scale	20 / 1	Parts No.:
②			Date		065-505
①			Drawn		Name:
Mark	Date	Description	Appro.	Checked	T.Hiruta
Alterations			Approved	SETTING STEM	
Material				Drawing No.: 5050S000	
Heat Treatment				MIYOTA CITIZEN WATCH CO., LTD. TOKYO, JAPAN	
Hardness					
Plating					